



# ORDER FORM COVERSHEET

1208 Houston Clinton Dr., Burnet, Texas 78611  
(512) 715-0808 | Toll-Free: (833) 715-0810 | Fax: (512) 715-0811

**ORDERS@GIBALTARGLOBAL.COM**

**ALL ORDERS MUST HAVE A COMPLETED COVER SHEET TO PROCESS WITHOUT ANY DELAYS**

**\*\*PLEASE ALLOW 3-5 BUSINESS DAYS TO PROCESS ORDERS PLUS SHIPPING/TRANSIT TIME \*\***

<b>DATE:</b>	PLEASE CHECK ALL APPLICABLE BOXES	<b>QUOTE NEEDED FOR:</b>	<b>MATERIALS</b>	<b>FREIGHT</b>
<b>COMPANY NAME:</b>				
<b>CONTACT NAME:</b>				
<b>PHONE NUMBER:</b>				
<b>FAX NUMBER:</b>				
<b>EMAIL:</b>				

\* PLEASE INCLUDE YOUR EMAIL ADDRESS SO WE CAN SEND YOU AN ORDER CONFIRMATION FOR APPROVAL PRIOR TO SHIPPING (BE SURE YOUR EMAIL ADDRESS IS LEGIBLE)

<b>PO NUMBER:</b>	<b>COUNTY &amp; STATE:</b>
-------------------	----------------------------

<b>SHIPPING ADDRESS:</b>	<b>BILLING ADDRESS:</b>

<b>SHIPPING CONTACT:</b>		<b>RECEIVING HOURS:</b>	
<b>SHIPPING PHONE:</b>		<b>RECEIVING HOURS:</b>	

\*\*\* PLEASE LIST ANY SPECIAL DELIVERY NEEDS BELOW ie. CALL AHEAD REQUIREMENTS, LIFT GATE REQUIRED, LIMITED ACCESS, RESIDENTIAL ADDRESS, ETC.\*\*\*

\*\*PLEASE NOTE THAT IF ANY PERTINENT INFORMATION FOR DELIVERY IS NOT LISTED IT COULD RESULT IN A REDELIVERY CHARGE OR FEE THAT WILL BE BILLED TO THE CUSTOMER DIRECTLY OR VIA GIBRALTAR ONCE DISCOVERED\*\*

**Notes:**

FOR QUESTIONS REGARDING ORDERS PLEASE CONTACT JOHN JANSEN AT (512) 715-0808. JJANSEN@GIBALTARGLOBAL.COM

FOR TECHNICAL QUESTIONS CONTACT INFO@GIBALTARGLOBAL.COM

\*\*PRICES DO NOT INCLUDE SHIPPING & HANDLING CHARGES \*\*



**SYSTEM TYPE: MASH 16**

**TO ORDER REPLACEMENT PARTS, CONTACT:**

Gibraltar Global LLC  
 1208 Houston Clinton DR  
 Burnet, TX 78611

Toll Free: (833) 715-0810      Office:(512) 715-0808  
 Email: [ORDERS@gibraltarglobal.com](mailto:ORDERS@gibraltarglobal.com)      Fax: (512) 715-0810

PART #	ITEM / DESCRIPTION	PRICE	UNIT	QUANTITY	EXTENDED AMT
4-HPIN-ALUM	TL-4 3 Aluminum Cable Hairpin	\$ 38.25	EA		
4-LOCK	TL-4 Cable Lockplate	\$ 17.25	EA		
U-LOCK	U-Bolt Lockplate Assembly (Consists of Lockplate and 4 U-blts)	\$ 30.00	SET		
4-LNP-S	TL-4 Line Post / Socketed (57")	\$ 78.75	EA		
4-LNP-D	TL-4 Line Post / Driven (84")	\$ 109.25	EA		
AP-MASH-4	MASH Anchor Post - 4 Cable	\$ 761.50	EA		
SOCK-S	30" Socket 4" x 3" -15" long W/ (4) 16" bars	\$ 58.00	EA		
SOCK-P	4x3x15" Plastic Socket	\$ 13.25	EA		
TUBE-PL	15" Tube Socket 4" x 3" with welded plate	\$ 29.25	EA		
TUBE-D	42" Driven Socket 4" x 3" with Post Stop at 15"	\$ 89.50	EA		
CRP-MASH-4CBL	Cable Release Post -4 Cable MASH	\$ 416.50	EA		
TKW	Terminal Keeper Wire (12-Ga.x 12" long)	\$ 2.25	EA		
TP1-4	Terminal Post No.1/ Weak 48" (4-Hole)	\$ 89.95	EA		
TP4-4	Terminal Post No.4/ Standard 57" (3-Hole)	\$ 99.50	EA		
J-BLT	J-Bolt (3/4")	\$ 14.75	EA		
ATF-1"	Anchor Terminal Fitting (1") Includes Turnbuckle	\$ 211.25	EA		
ATF-End 1"	Anchor Terminal Fitting End 1 18" x 1" Rod and Acorn	\$ 88.50	EA		
CSTB-1"	Cable Splice Turnbuckle (1") Open Body	\$ 217.00	EA		
TORP	"Torpedo" Splice	\$ 83.50	EA		
ACORN	Acorn	\$ 39.75	EA		
WEDGE	Wedge For Acorn	\$ 3.00	EA		
DLN	Delineator / Reflective Object Marker - <i>Specify Yellow or White</i>	\$ 3.00	EA		
CBL-PRE	Pre-stretched Cable (3/4" Guardrail Cable) <b>*[See Note 1]</b>	\$ 3.00	LF		
EXCL-CAP	Excluder Cap - Post Base	\$ 4.25	EA		
CAP	Post Cap Sleeve - Post Top	\$ 11.25	EA		
<b>TOOLS</b>					
T-MTR	Tension Meter with Case <b>*[ See Note 2]</b>	\$ 3,150.00	EA		
CABLE DIVIDER	CABLE DIVIDING TOOL	\$ 96.00	EA		
SPACER BLOCK	NYLON SPACER BLOCK	\$ 21.25	EA		
RETAINING CLAMP	CABLE RETAINING CLAMP	\$ 256.50	EA		
TRAINING	Installation and Repair Training <b>*[ See Note 3]</b>	<b>CALL FOR DETAILS</b>			
<b>NOTE-1</b>	Cable sold as a complete 2000' spool only (unless remnant pieces are available)	<b>PARTS TOTAL</b>			
<b>NOTE-2</b>	Gibraltar Global recommends that the tension of the cables be checked after every repair	<b>SHIPPING &amp; HANDLING</b>			
<b>NOTE-3</b>	We recommend that ALL contractors installing or repairing our systems be trained and certified by Gibraltar Global <i>* Please call for more information</i>	<b>ORDER TOTAL</b>			

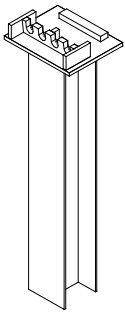

**AP-MASH-4CBL**  
MASH Anchor Post



**CRP-MASH-4CBL**  
MASH Cable Release Post

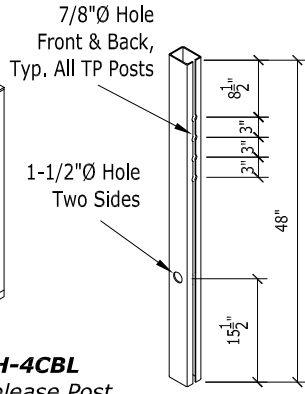

**TP1-4**  
Terminal Post  
No. 1/Weak

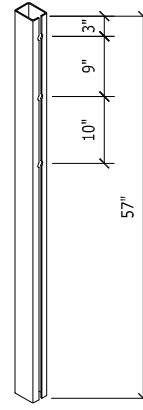

**TP4-4**  
Terminal Post

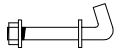

**J-BLT**  
J-Bolt



**RH STUD ATF ASSY**  
Anchor Terminal Fitting RH Stud



**ATF**  
Anchor Terminal Fitting



**ATF-END**  
Anchor Terminal Fitting End

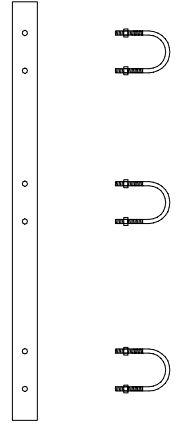

**U-Bolt Lock-Plate Assembly**

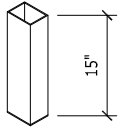

Tube Socket  
(Steel or Plastic)

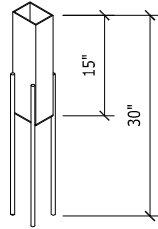

**SOCK-S**  
Short Rebar Socket

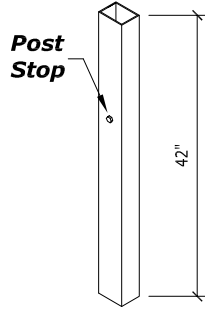

**TUBE-D**  
Driven Socket

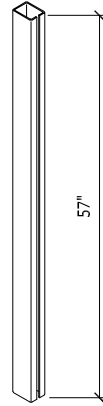

**4-LNP-S**  
Line Post/Socketed

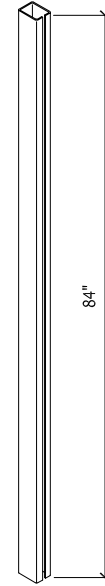

**4-LNP-D**  
Line Post/Driven

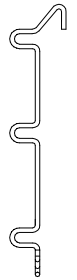

**4-HPIN Alum.**  
3 Cable Alum. HPIN

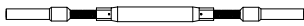

**RH/LH SWAGE ASSY**



**CSTB**  
Cable Splice Turnbuckle



**4-LOCK**  
TL4 Lockplate



**WEDGE**



**ACORN**  
Acorn w/ Wedge



**TORP**  
Longitudinal Section ONLY  
Torpedo Cable Splice

**PROPRIETARY TO GIBRALTAR**



**MASH 2016 TL4 System Parts**

Gibraltar Cable Barrier Systems

Scale:	NTS	Date:	8/26/21
Layout:	ANSI B	Drafter:	BH